

YASKAWA



YASKAWA AC Drive Fan, Pump & HVAC E1000

400 V Class, 0.75 to 630 kW



The Green Inverter

Certified for ISO9001
and ISO14001



E

Super Energy-saving

High Efficiency driven Induction Motor

Theoretical Maximum Energy Saving Operation

With lighter load, the efficiency tends to be lower. Under energy-saving control, it helps to improve the efficiency up to the theoretical maximum efficiency based on the Steinmetz's motor characteristics calculation. The motor operation cost can drastically be reduced.

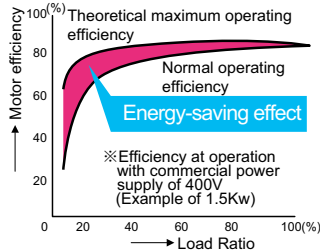

More Energy Saving!

The graph below shows the energy required for the operation of air blower control by inverter, and with inverter + energy-saving control.

- With inverter control, power saving from P1 to P2
- With energy-saving control, power saving from P2 to P3

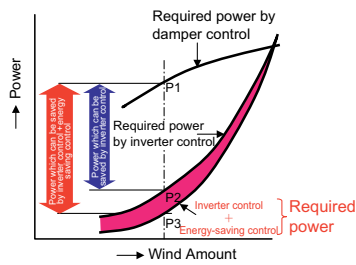

Drive Optimization Corresponds to Load & Temperature changes

- ▲ With lighter load, the voltage is reduced to keep up with the efficiency. In case of heavier load, the voltage will increase to maintain a high torque operation.
- ▲ The drive will search for optimum drive point automatically, even though the electrical and mechanical characters of the motor or machine changed during the operation. It helps to prolongs the life of motor due to the influence of temperature.

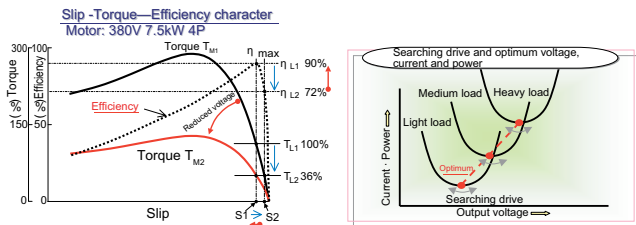

Capable of Driving Induction & Synchronous

- ▲ Not only driving induction motor but also synchronous motor and with just one parameter change.
- ▲ Capable of switching between the induction motor and the synchronous motor through parameter setting.

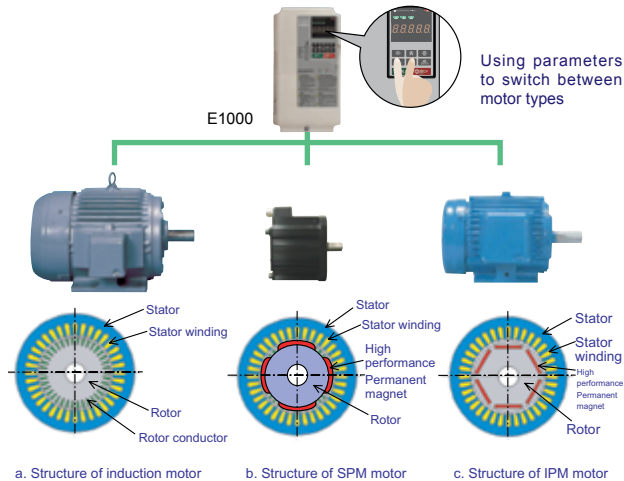

Synchronous Motors Is More Efficient Drive Than High Efficient Induction Motors

- ▲ Even though high efficiency induction motor has good performance at rated speed and rated load, but synchronous motor has the best performance on all speed range and load condition.

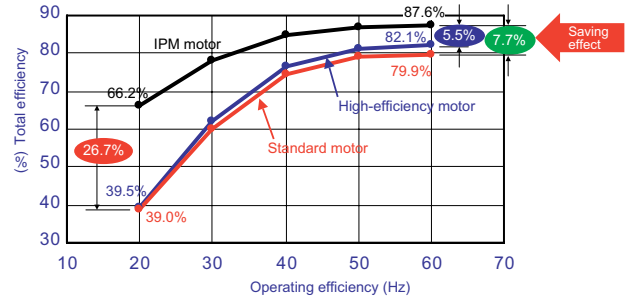

• Characteristics of frequency - total efficiency (example of 400V, 3.7kW)

Drive Constant Torque Compressor With High Efficiency. (IM & SM)

- ▲ With auto torque boost function, it can start constant torque compressor easily.
- ▲ Even with load fluctuation, the hunting prevention control can maintain the machine stability.

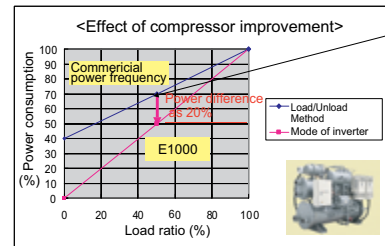

The lighter the load, the higher the energy saving rate. For example, 20% energy saving is available when the load ratio is 50%.

Control Stable Pressure And High Efficiency For Constant Torque Compressor

- ▲ Optimum drive by energy saving control and overshoot suppression.
- ▲ High performance PID control function can prevents pressure and power fluctuation, and thus maintain stable operation.

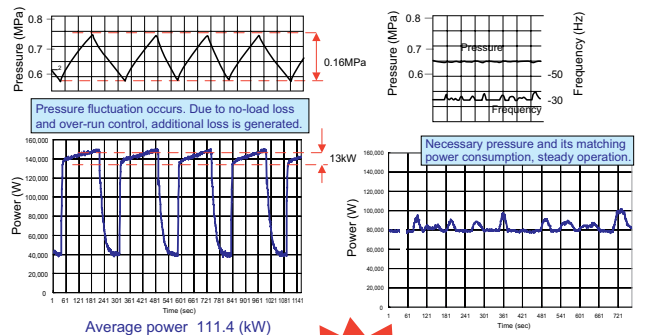

(Note) Comparison run of 132kW motor at 60% of load ratio

26% Energy Saving

E

Ease of Operation & Compliance with Environment

Built-In Energy-Saving Control With Auto-Tuning Function

- Both the induction motor and the synchronous motor have built-in Auto-Tuning function to achieve the highest performance levels possible.
- Stationary and Rotational Auto-Tuning can be selected.

Types of Auto-Tuning

Induction motor Auto-Tuning		Synchronous motor Auto-Tuning	
Rotational Auto-Tuning	Applications requiring energy-saving control, or high control performance. In addition, it will be implemented when carrying out the presumption type speed search.	Synchronous motor Parameter setting	There are motor nameplate or test reports, etc. Therefore, the parameters can be set when the detailed data of the motor is known.
Stationary Line-to-Line resistance Auto-Tuning	When the cable length is changed, or when the motor capacity does not match the inverter capacity, the control performance can be improved. In addition, it will be implemented when carrying out the presumption type speed search.	Synchronous motor Stationary Auto-Tuning	Motor parameters necessary for auto-tuning under the stationary state.
		Stationary armature resistance Auto-Tuning	When the cable length is changed, or when the motor capacity does not match the inverter capacity, the control performance can be improved. In addition, it will be implemented when carrying out the presumption type speed search.

Tackling Power Lost and Recovery

- 2 types of momentary power loss compensation functions can be selected.
- Can be used for the sensorless control of the induction motor or the synchronous motor

Speed search function

It can restart easily by searching for a rotary speed under a coasting speed.

Major Application

Fluid machine that is installed with a rotor, such as fan and blower, etc.

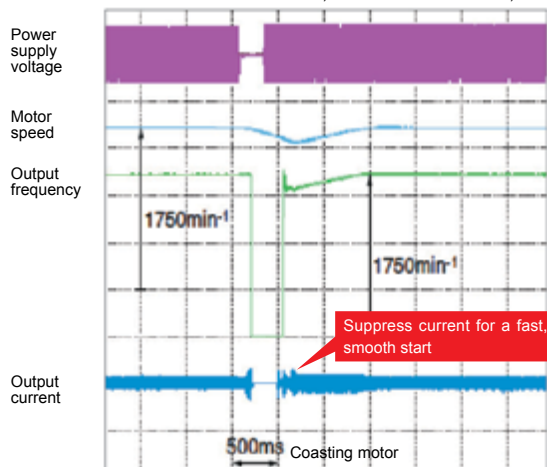

KEB (Kinetic Energy Back-up) function

Keep the running without allowing it to coast.

Major Application

A situation requires an emergency stop at the time of an momentary power loss

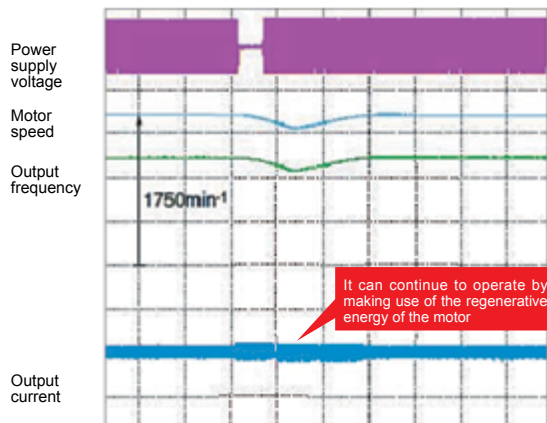

(Note) Power loss detector and other devices must be installed. Under certain load conditions, the inverter may trip, making the motor turn into a coasting state.

Environmental Features

Environment-resistant design

- An environment-resistant enhanced product that is moisture-proof, dust-resistant, oil-resistant and vibration-resistant, etc.

Compliance RoHS

- The standard product complies with the RoHS (European Restriction Of Hazardous Substances) directive



Noise Reduction

- Swing PWM mode is adopted, reducing harsh noise while suppressing the electromagnetic interference

- Noise comparison on that of former products with the Swing PWM mode

Former products

E1000

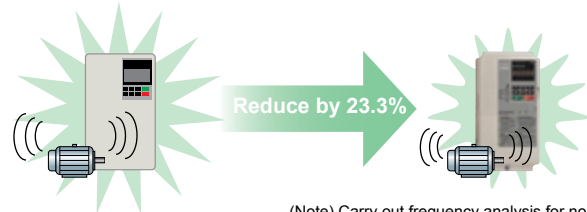

(Note) Carry out frequency analysis for noise values to compare its peak.

Suppressing Power Supply Harmonics

- A DC reactor minimizes harmonic distortion, standard on drives 30 kW and above.

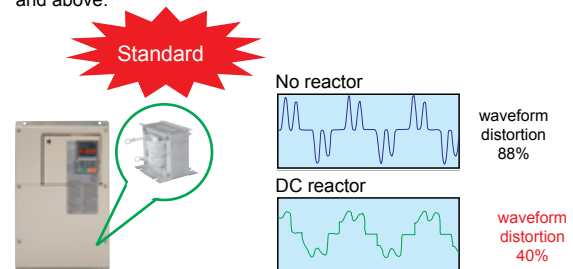

High Performance I/O function

4~20mA output available

It can monitor the cumulative power consumption

- In addition to monitoring the power, it can also monitor the cumulative power consumption.
- Like the cumulative electricity meter available in the market, it can output multifunction pulses signal to host PLC
- These values can be monitored by using the communication options.

E

Easy of Operation & Compliance with Environment

Easy Maintenance

Engineering Tool DriveWizard Plus*

- ▲ Manage the unique settings for all your drives right on your PC.
- ▲ An indispensable tool for drive setup and maintenance. Edit parameters, access all monitors, create customized operation sequences, and observe drive performance with the oscilloscope function.
- ▲ The Drive Replacement feature in DriveWizard Plus saves valuable time during equipment replacement and application upgrades by converting previous Yaskawa product parameter values to the new E1000 parameters automatically.
- ▲ A USB port is provided for easy connection to the PC.



- Connect with the PC via the USB port
- (Note) A communication port for the original WV103 cable is provided. Please remove the operator before use.

Easy Set-Up And Maintenance

- ▲ Standard LED operator is provided with a built-in copy function. Easily upload/download the parameters. General-purpose LAN cables can be used for operator extension cord.
- ▲ LCD digital operator option is provided.
- ▲ The option is provided with a USB copy unit, and can also copy parameters of the inverter.
- ▲ In the **set-up mode**, minimal parameters necessary for operation can be set.
- ▲ The parameters changed can be easily confirmed in the **calibration mode** (comparison mode).



- LED operator (Standard)
- LCD operator (Option)
- With USB Copy unit (Option)

Changed Value ● Verify Menu example

Name	Parameter No.	Default	Set value:
Selection of frequency command	b1-01	1	0
Acceleration time 1	C1-01	3.00s	3.50s
Deceleration time 1	C1-02	3.00s	3.50s
...

Customization Of Inverter To The User Preference

- ▲ Visual programming function DriveWorksEZ is included
Via the drag-and-drop operation of the PC, it can simply compile the inverter into a special inverter applicable to the machinery of the user. It can also compile special actions or new detection functions, and write in the inverter.
- Compilation detection function
For example: machinery aging diagnosis (machinery torque ripple detection) function

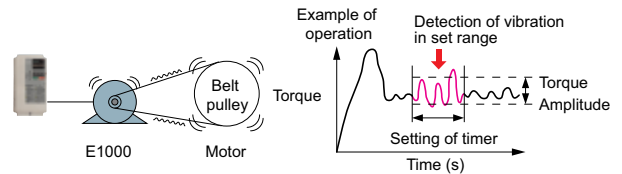

(Note) Please inquire separately when you need to use this function.

Breeze-Easy Setup

- ▲ Immediate set-up with Application Presets
E1000 automatically sets parameters needed for most major applications. Simply selecting the appropriate application instantly optimizes the drive for top performance, saving enormous time setting up for a trial run.



- Set simply via parameters

The optimum values of the parameters of various items required for operation will be automatically set by simply selecting the application.

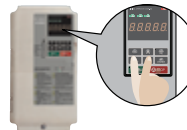

Setting	Application
00	General-purpose
01	Water Supply Pump
03	Fan for air supply and exhaust
04	AHU (HVAC) fan
05	Air compressor

Various Communication Option Cards

- ▲ Standard RS-422/485 communication function is provided
- ▲ If the communication option cards are installed, they can be used for various on-site networks, such as PROFIBUS-DP*, DeviceNet*, CC-Link*, CANopen*, LONWORKS* and MECHATROLINK-II*, etc.
* : Available soon
(Note) The product names are registered trademarks of various companies.

- ▲ They can save wiring and space for convenient design, installation and maintenance of machinery

E

Safety & High Reliability

Safe Environment

Controlled Stop Despite Power Loss

▲ Should a power outage occur, E1000 can bring the application to controlled stop quickly and safely using the KEB function.

- Quickly ramp to stop with KEB function

[Most suitable application]

A situation requires an emergency stop at the time of a momentary power loss.

Previous model

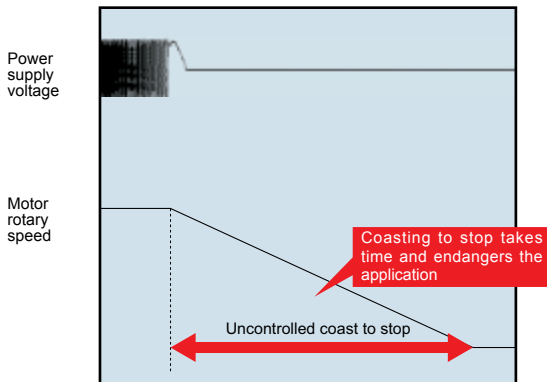

E1000

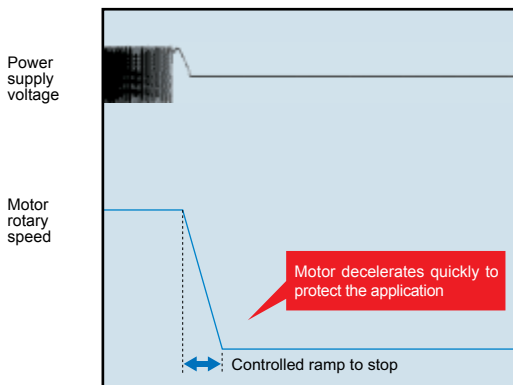

Long Life Performance

10 years of Durable Performance

▲ Cooling fan, capacitors, relays, and IGBTs have been carefully selected and designed for a life expectancy up to ten years.*

* : Assumes the drive is running continuously for 24 hours a day at 80% load with an ambient temperature of 40°C.

Performance Life Monitors

▲ Yaskawa's latest drive series is equipped with performance life monitors that notify the user of part wear and maintenance periods to prevent problems before they occur.

▲ The operation time, operation times, peak current, overload state and degradation parts state can be monitored via the digital operator.

Easy Maintenance

The First Terminal Board with a Parameter Backup Function

▲ The terminal block's ability to save parameter setting data makes it a breeze to get the application back online in the event of a failure requiring drive replacement.

- Detachable terminal block with parameter backup function



Built-in parameter

Name	Number	Setting
Selection of control mode	A1-02	0
Selection of frequency command	b1-01	1
Selection of operation command	b1-02	1

- Less dust and easy replacement with top mounted fan design



Machine Protection

In addition to extra-large torque detection, extra-small torque can also be detected

▲ The mechanical system can be protected without expensive detective instruments.

▲ Different from the electronic thermal protection, it can be set independently.

Continuous Operation

Automatic continuous operation function when the frequency losses is provided

▲ During operation, even with the frequency command of the analog or pulse train losses, it can still continue to operate automatically.

(It can be selected by parameter)



Standard Specifications

400 V Class

Model: CIMR-E□4A		Specifications													
		0002	0004	0005	0007	0009	0011	0018	0023	0031	0038	0044	0058	0072	0088
Maximum applicable motor capacity (kW) *1		0.75	1.5	2.2	3	3.7	5.5	7.5	11	15	18.5	22	30	37	45
Input	Rated input current (A) *2	2.1	4.3	5.9	8.1	9.4	14	20	24	38	44	52	58	71	86
	Rated output capacity (kVA) *3	1.6	3.1	4.1	5.3	6.7	8.5	13.3	17.5	24	29	34	44	55	67
Output	Rated output current (A) *4	2.1	4.1	5.4	6.9	8.8	11.1	17.5	23	31	38	44	58	72	88
	Overload tolerance	120% of rated output current for 60 seconds													
	Carrier frequency	2~15kHz (It can be changed via parameters.)													
	Maximum output voltage (V)	3-phase 380~480V (corresponding input voltage)													
	Maximum output frequency (Hz)	200Hz (It can be changed via parameters.)													
	Rated voltage, rated frequency	AC: 3-phase 380~480V 50/60Hz DC: 510~680V													
Power supply	Allowable voltage fluctuation	-15~10%													
	Allowable frequency fluctuation	±5%													
	Power-supply device capacity (kVA)	2.3	4.3	6.1	8.1	10.0	14.5	19.4	28.4	37.5	46.6	54.9	53.0	64.9	78.6

Model: CIMR-E□4A		Specifications											
		0103	0139	0165	0208	0250	0296	0362	0414	0515	0675	0930	1200
Maximum applicable motor capacity (kW) *1		55	75	90	110	132	160	185	220	250	355	500	630
Input	Rated input current (A) *2	105	142	170	207	248	300	346	410	465	657	922	1158
	Rated output capacity (kVA) *3	78	106	126	159	191	226	276	316	392	514	709	915
Output	Rated output current (A) *4	103	139	165	208	250	296	362	414	515	675	930	1200
	Overload tolerance	120% of rated output current for 60 seconds											
	Carrier frequency	2~10kHz (It can be changed via parameters.)						2~5kHz (It can be changed via parameters.)					
	Maximum output voltage (V)	3-phase 380~480V (Relative to input voltage)											
	Maximum output frequency (Hz)	200Hz (It can be changed via parameters.)											
	Rated voltage, rated frequency	AC: 3-phase 380~480V 50/60Hz DC: 510~680V											
Power supply	Allowable voltage fluctuation	-15~10%											
	Allowable frequency fluctuation	±5%											
	Power-supply device capacity (kVA)	96.0	129.9	155.5	189	227	274	316	375	416	601	843	1059

- *1 The maximum applicable motor capacity is the capacity of the 4-pole, 50Hz, 400V standard motor manufactured by the Company. The more rigorous selection method is to make the rated output current of the inverter greater than the rated current of the motor when selecting the model.
- *2 Refer to the rated output current value. This value is not only affected by the power transformer, the reactor at the input side and the wiring conditions, but also fluctuates with the impedance at the power supply side.
- *3 Rated output capacity is calculated with a rated output voltage of 440V.
- *4 Increasing the carrier frequency requires a reduction in current.
- *5 The cumulatively calculated overload starting current is the objective current value when the inverter starts to cumulatively calculate the overload fault (OL2) of the inverter. The inverter will continue to operate when it exceeds the rated output current value and lower than such current value. However, it is noted that, when the ambient temperature is too high or the ventilation is poor, the heat sink overheat alarm (OH1) or heat sink overheat fault may occur. At this time when the inverter capacity needs to be improved or the inverter gives an overheat alarm, it will continue to operate using the progressive frequency decrease.

Model Designation

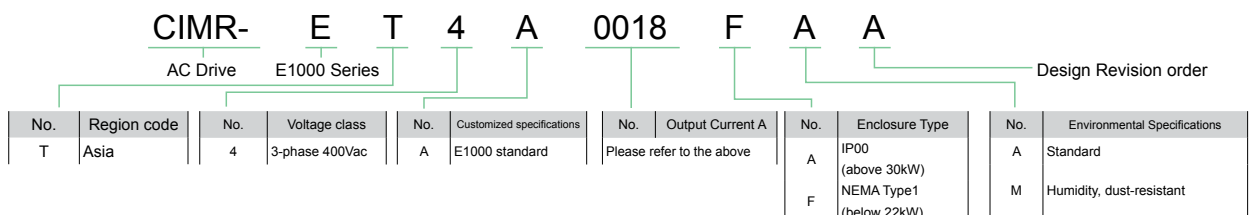

Contact Yaskawa for more information on environmental specifications.



Standard Specifications

Common Specifications

(Note) In order to extend the product life of the converter, please install the inverter under the best circumstances.

	Item	Specifications
Control characteristics	Control method	V/f control, vector control for PM
	Frequency control range	0.01~200Hz (varies as per the inverter capacity)
	Frequency accuracy (temperature fluctuation)	Digital reference: within maximum output frequency $\pm 0.01\%$ (-10~+40°C) Analog reference: within maximum output frequency $\pm 0.1\%$ (25°C $\pm 10^\circ\text{C}$)
	Frequency setting resolution	Digital reference: 0.01Hz Analog reference: 0.03 Hz / 60 Hz (11bit)
	Output frequency resolution (operation resolution)	0.001Hz
	Frequency setting signal	-10~10V, 0~10V, 4~20mA, pulse train
	Starting torque	V/f control 150%/3Hz, vector control 100%/5% speed for PM
	Speed control range	V/f control 1:40, vector control 1:20 for PM
	Speed control accuracy	$\pm 2\sim 3\%$ (V/f control) *1
	Speed response	3Hz (V/f control)
	Acceleration/deceleration time	0.00~6,000.0 seconds (separate setting of acceleration or deceleration: 4 types of switching)
	Braking torque	About 20%
	Voltage/frequency characteristics	Any program, V/f curve
	Main control functions	Momentary power loss restart, speed search, overtorque detection, 8-speed operation (maximum), acceleration/deceleration switch, S-shaped acceleration/deceleration, 3-wire system sequential control, DWELL function, cooling fan ON/OFF function, slip frequency compensation, torque compensation, frequency jump, upper/lower limit setting of frequency commands, DC brake on startup/stop, overexcited deceleration, high slip frequency brake, PI control (with suspension function), energy-saving control, MEMOBUS communication (maximum 115.2kbps for RS-422/485), fault retry, DriveWorksEZ (customization function), detachable terminal block with parameter backup function, KEB, overexcited deceleration, overvoltage suppression function and insufficient torque detection, etc.
Protective functions	Motor protection	Electronic thermal protection
	Momentary overcurrent protection	Stop when greater than 175% of the rated output current
	Overload protection	Stop at 120% of the rated output current within 60 seconds *2
	Overvoltage protection	Class 400V: stop when the DC voltage in the main loop is greater than 820V approximately
	Undervoltage Protection	Class 400V: stop when the DC voltage in the main loop is less than 380V approximately
	Momentary power loss compensation	Stop for more than 15ms approximately *3. Depending on the parameter settings, the power loss will be restored in about 2 seconds, and the operation will continue *4
	Heat sink overheat protection	Protected by thermistors
	Stalling prevention	To prevent stalling during acceleration/deceleration, and to prevent stalling during operation
	Ground Protection	Protect via the electronic loop *5
	Display during charging	Before the DC voltage in the main loop reaches less than about 50V, the charging indicator will be on
Environment	Installation site	Indoor
	Ambient temperature	-10~40°C (enclosed wall-mount type), -10~50°C (in-cabinet-mount type)
	Humidity	Below 95%RH (no condensation)
	Storage temperature	-20~60°C (short-time temperature during transport, etc.)
	Altitude	Below 1000m
	Vibration	10~20Hz: 9.8m/s ² 20~55Hz: 5.9m/s ² (4A0002~4A0675) 2.0m/s ² (4A0208~4A0362)
	Protective design	In-cabinet-mount type (IP00), enclosed wall-mount type (NEMA TYPE 1) *6

*1 Depending on different installation conditions and motor types, the speed control precision varies. Please contact the Company for more information.

*2 When output frequency is less than 6Hz, even it is within 120% of the rated output current and 60 seconds, the overload protection function may act.

*3 Depending on the rotary speed or load conditions, the deceleration time may be shorter.

*4 Vary depending on the capacity. For an inverter with a model below Type CIMR-E□4A0002~4A0031, in order to ensure an momentary power loss compensation of 2 seconds, an momentary power loss compensation unit needs to be used.

*5 Since there is possibility of grounding short circuit inside the operating motor coil, it may play a protective role in the following conditions now and then.

· Low-resistance grounding short circuit of motor cables or terminal blocks, etc.

· When the power is on under a grounding short circuit state

*6 After removing the upper protective cover of NEMA Type1 converter (4A0002~4A0044), the protective grade will change to IP20.

Standard Connection Diagram

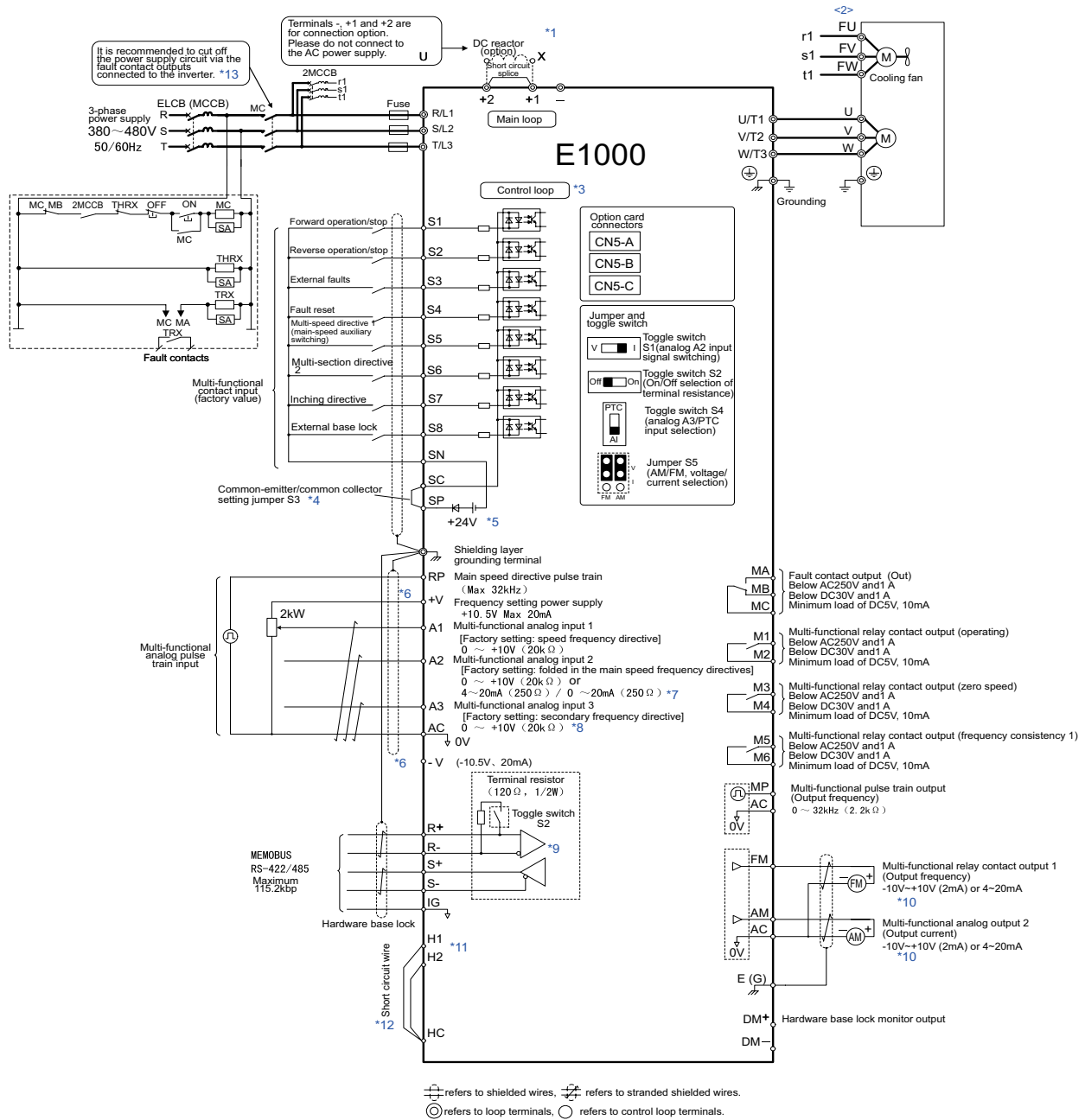

- *1 When installing the DC reactor (option), please be sure to remove the short circuit splice between Terminals +1 and +2. CIMR-E□4A0058~4A0675 converter is provided with a built-in DC reactor.
- *2 When a self-cooling motor is adopted, the cooling fan motor is unnecessarily to be wired.
- *3 When the inverter is connected to the control power supply, if the main loop is closed only, please use 24V control power supply unit (option).
- *4 Refer to the connection conditions (factory setting) of the sequential control input signals (S1~S8) during the sequential control connection (0V common port/common-emitter mode) according to the voltage-free contacts or NPN transistors. When carrying out the sequential control connection according to PNP transistors (+24V common port /common collector mode) or setting a +24V power supply outside the inverter, please refer to the User Guide.
- *5 The maximum current capacity of the power supply is 150mA.
- *6 Both the maximum output current capabilities of +V and -V voltages of the control loop terminals are 20mA. Please do not short circuit between ACs of the control loop terminals +V and -V. Otherwise, it will cause a malfunction or fault.
- *7 For Terminal A2, the voltage command input or current command input (factory setting) can be selected via the toggle switch S1.
- *8 For Terminal A3, the analog input or PTC input can be selected via the toggle switch S4.
- *9 When using the MEMOBUS communication, if an end inverter is adopted, then the terminal resistor (toggle switch S2) shall be connected.
- *10 Multi-functional analog monitor outputs are the outputs for analog frequency meters, ammeters, voltmeters, wattmeters and other indicating meters. They cannot be used for feedback control and other control operations.
- *11 The common-emitter/common collector mode settings of the hardware base lock are the same as those of the sequential control input. When selecting the external power supply via Jumper S3 instead of using the hardware base lock, the short circuit wire of the hardware base lock shall be unplugged to connect an external power supply.
- *12 When stopping via an external safety switch, please be sure to remove the short circuit wires between H1-HC and H2-HC.
- *13 When using the fault retry function, if L5-02 (fault contact output action selection in the fault retry) is set to 1 (output fault contact in the fault retry) for use, then the fault signal will be output in the fault retry, and at the same time, the power will be cut off. Please note when cutting off the loop. The factory setting of L5-02 is 0 (do not output fault contacts in the fault retry).

Warning! Safety measures on reboot of the machine

Please wire the operation/stop loop and safety loop correctly, and confirm that the machinery is in a normal state after the inverter is powered on. If the wiring is incorrect, personal injury may be caused due to sudden starts of the machinery.

Enclosure Panel (NEMA Type1)

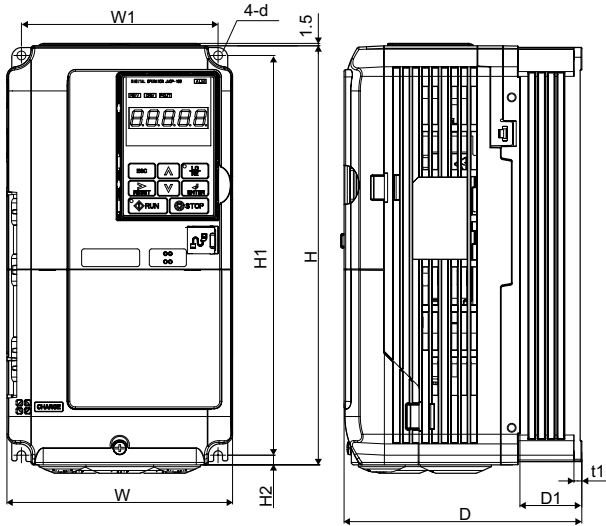

Figure 1

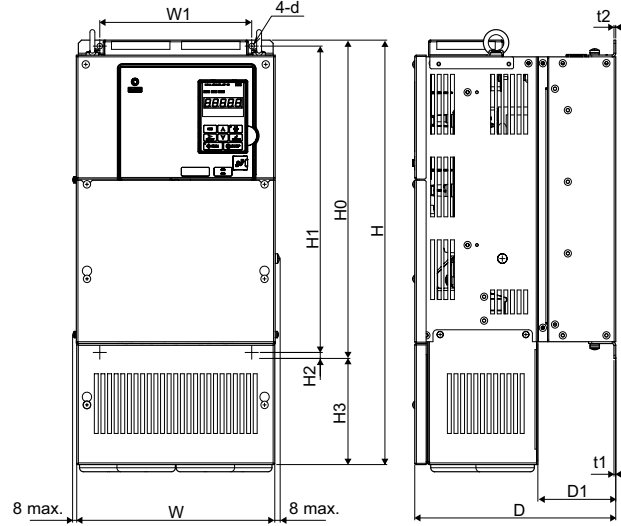

Figure 2

External dimensions (Enclosure Panel (NEMA Type1): 400V Class)

Model CIMR-EC4A	Dimensions (mm)													Gross Weight (kg)
	Figure	W	H	D	W1	H0	H1	H2	H3	D1	t1	t2	d	
0002	1	140	260	147	122	-	248	6	-	38	5	-	For M5	3.2
0004		140	260	147	122	-	248	6	-	38	5	-	For M5	3.2
0005		140	260	147	122	-	248	6	-	38	5	-	For M5	3.2
0007		140	260	164	122	-	248	6	-	55	5	-	For M5	3.4
0009		140	260	164	122	-	248	6	-	55	5	-	For M5	3.5
0011		140	260	164	122	-	248	6	-	55	5	-	For M5	3.5
0018		140	260	167	122	-	248	6	-	55	5	-	For M5	3.9
0023		140	260	167	122	-	248	6	-	55	5	-	For M5	3.9
0031		180	300	167	160	-	284	8	-	55	5	-	For M5	5.4
0038		180	300	187	160	-	284	8	-	75	5	-	For M5	5.7
0044	220	350	197	192	-	335	8	-	78	5	-	For M6	8.3	
0058	2 *1	254	465	258	195	400	385	7.5	65	100	2.3	2.3	For M6	23
0072		279	515	258	220	450	435	7.5	65	100	2.3	2.3	For M6	27
0088		329	630	258	260	510	495	7.5	120	105	2.3	3.2	For M6	39
0103		329	630	258	260	510	495	7.5	120	105	2.3	3.2	For M6	39
0139		329	730	283	260	550	535	7.5	180	110	2.3	2.3	For M6	45
0165		329	730	283	260	550	535	7.5	180	110	2.3	2.3	For M6	46
0208		456	960	330	325	705	680	12.5	255	130	3.2	3.2	For M10	87
0250		504	1168	350	370	800	773	13	368	130	4.5	4.5	For M12	106
0296		504	1168	350	370	800	773	13	368	130	4.5	4.5	For M12	112
0362		504	1168	350	370	800	773	13	368	130	4.5	4.5	For M12	117

*1 Build-to-Order. Please contact with the agent or sales representative of the Company for inquiries.

Open-Chassis (IP00)

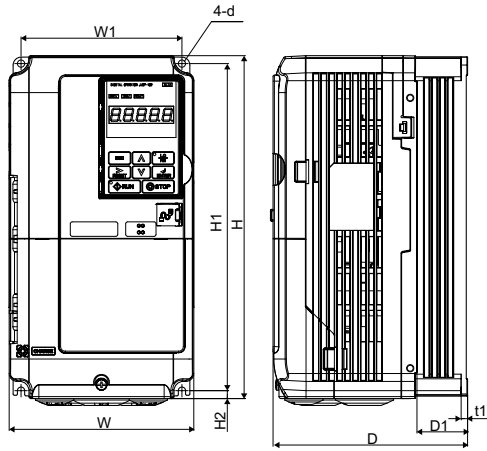

Figure 1

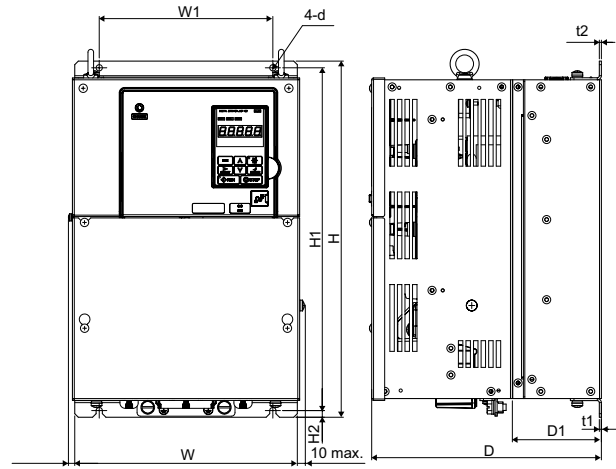

Figure 2

External dimensions (Open-Chassis (IP00): 400V Class)

Model CIMR-EC4A	Figure	Dimensions (mm)										Gross Weight (kg)	
		W	H	D	W1	H1	H2	D1	t1	t2	d		
0002	1	140	260	147	122	248	6	38	5	-	For M5	3.2	
0004		140	260	147	122	248	6	38	5	-	For M5	3.2	
0005		140	260	147	122	248	6	38	5	-	For M5	3.2	
0007		140	260	164	122	248	6	55	5	-	For M5	3.4	
0009		140	260	164	122	248	6	55	5	-	For M5	3.5	
0011		140	260	164	122	248	6	55	5	-	For M5	3.5	
0018		140	260	167	122	248	6	55	5	-	For M5	3.9	
0023		140	260	167	122	248	6	55	5	-	For M5	3.9	
0031		180	300	167	160	284	8	55	5	-	For M5	5.4	
0038		180	300	187	160	284	8	75	5	-	For M5	5.7	
0044		220	350	197	192	335	8	78	5	-	For M6	8.3	
0058		2	250	400	258	195	385	7.5	100	2.3	2.3	For M6	21
0072			275	450	258	220	435	7.5	100	2.3	2.3	For M6	25
0088			325	510	258	260	495	7.5	105	2.3	3.2	For M6	36
0103	325		510	258	260	495	7.5	105	2.3	3.2	For M6	36	
0139	325		550	283	260	535	7.5	110	2.3	2.3	For M6	41	
0165	325		550	283	260	535	7.5	110	2.3	2.3	For M6	42	
0208	450		705	330	325	680	12.5	130	3.2	3.2	For M10	79	
0250	500		800	350	370	773	13	130	4.5	4.5	For M12	96	
0296	500		800	350	370	773	13	130	4.5	4.5	For M12	102	
0362	500		800	350	370	773	13	130	4.5	4.5	For M12	107	

*1 After the protective cover of the CIMR-EC4A0002-0044 inverter is removed, its protective class will change to IP20.

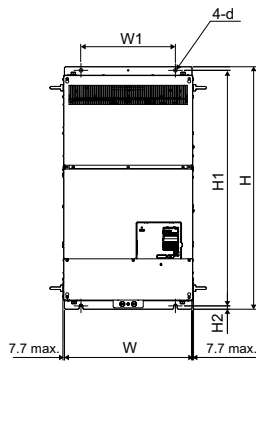

Figure 3

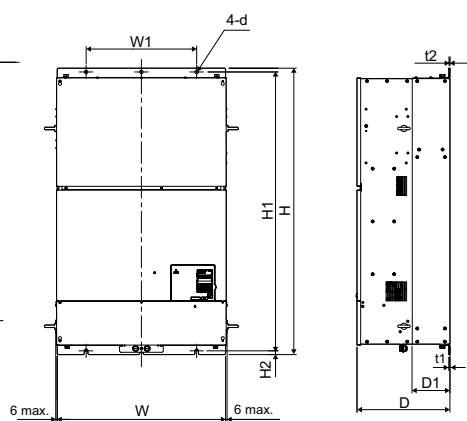

Figure 4

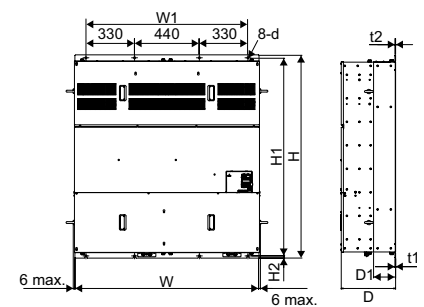



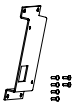
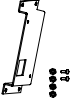

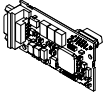
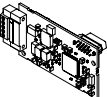
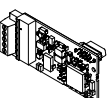
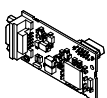
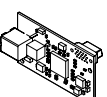

Figure 5

Model CIMR-EC4A	Figure	Dimensions (mm)										Weight (kg)
		W	H	D	W1	H1	H2	D1	t1	t2	d	
0414	3	500	950	370	370	923	13	135	4.5	4.5	For M12	125
0515	4	670	1140	370	440	1110	15	150	4.5	4.5	For M12	221
0675												
0930	5	1250	1380	370	1100	1345	15	150	4.5	4.5	For M12	545
1200												555

Option	Model number	Description	
Interface options			
	LCD Operator	JVOP-180	Digital operator with 8 languages, clear text LCD display, and copy function. Max. cable length for remote usage: 3m.
	Remote Operator Cable	WV001/WV003	Extension cable to connect the digital operator for remote operation. (1m or 3m) RJ-45 , 8 pin straight through, UTP CAT5e cable
	USB Copy Unit	JVOP-181	Parameters set in the inverter can be read, copied, verified and connected with the PC. Provided with a cable.
Attachment			
-	Attachment for external installation of heat sink	EZZ020800A/D/C/D	Installation kit for mounting the inverter with the heat sink outside of the panel. (Side-by-Side mounting possible)
-	NEMA1 Kit	EZZ020787	Installed in the in-cabinet-mount type (IP00), applicable to enclosed wall-mount type (NEMA Type 1).
	Installation Support Set A	EZZ020642A	The operator can be installed in the control cabinet.(for screw fixing)
	Installation Support Set B	EZZ020642B	The operator can be installed in the control cabinet.(for nut fixing) When there are weld studs inside the control cabinet, please use the nut-fixing type.
Other options			
	24V power supply	PS-A10HB	When the main loop power supply stops, supply power from the 24V control power supply unit to the control power supply. Even when the main loop power supply is cut off, or the inverter's parameters can be viewed, or the failure state can be confirmed.
-	DriveWizard Plus	-	A support tool (PC software) for inverter settings and parameter management via the PC
-	DriveWorksEZ	-	Advanced programming of the inverter can be carried out via the PC.
Option cards			
	PROFIBUS-DP	SI-P3 *	The inverter can be connected to the PROFIBUS-DP network.
	CC-Link	SI-C3 *	The inverter can be connected to the CC-Link network.
	DeviceNet	SI-N3 *	The inverter can be connected to the DeviceNet network.
	CANopen	SI-S3 *	The inverter can be connected to the CANopen network.
	MECHATROLINK-II	SI-T3 *	The inverter can be connected to the MECHATROLINK-II network.

24V Power Supply

The 24 V Power Supply Option maintains drive control circuit power in the event of a main power outage. The control circuit keeps the network communications and I/O data operational in the event of a power outage. It supplies external power to the control circuit only.

(Note) Parameter settings cannot be changed when the inverter is operating solely from this powers supply.



Connection Diagram

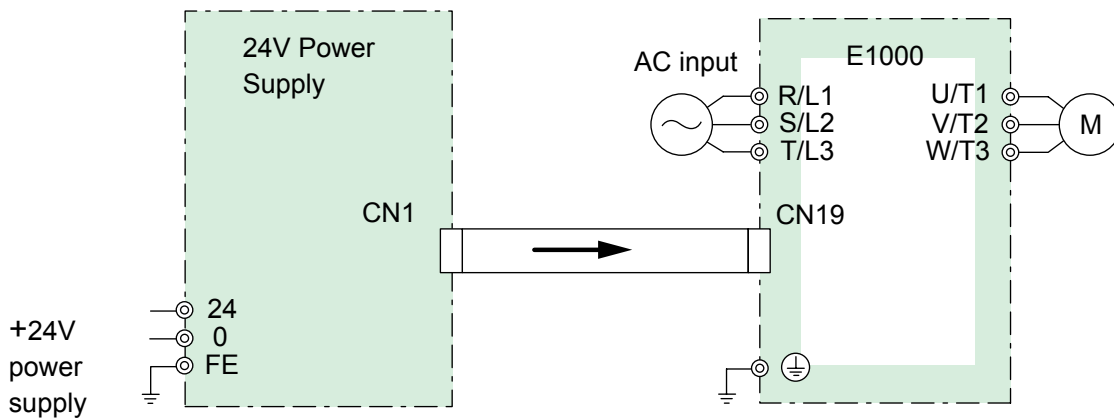

Model, order number

Model	Order No.
Class 400V: PS-A10H	PS-A10HB

For motors (400V) with capacity of 96V or more, use this unit (as a backup power source) in the event of a power loss.

(Note) This unit is not required when using a UPS (uninterruptible power supply) for emergency operation.

Fuse/Fuse Holder

In case of a component failure, in order to protect the system, it is recommended to connect a fuse or an MCCB (Moulded Case Circuit Breaker) at the inverter input side.

[Fuji Electric FA Components & Systems Co., Ltd.]

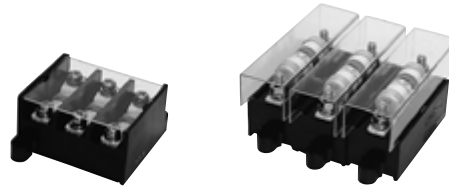

Class 400V

Inverter model CIMR-E□	Fuse		Fuse Holder	
	Manufacturer: Fuji Electric FA Components & Systems Co., Ltd.			
	Model	Rated fuse current (A)	Model	Quantity
4A0002	CR6L-20	20	CMS-4	3
4A0004	CR6L-30	30	CMS-4	3
4A0005	CR6L-50	50	CMS-4	3
4A0007	CR6L-50	50	CMS-4	3
4A0009	CR6L-50	50	CMS-4	3
4A0011	CR6L-50	50	CMS-4	3
4A0018	CR6L-75	75	CMS-5	3
4A0023	CR6L-75	75	CMS-5	3
4A0031	CR6L-100	100	CMS-5	3
4A0038	CR6L-150	150	CMS-5	3
4A0044	CR6L-150	150	CMS-5	3
4A0058	CR6L-200	200	-	-
4A0072	CR6L-250	250	-	-
4A0088	CR6L-250	250	-	-
4A0103	CR6L-300	300	-	-
4A0139	CR6L-350	350	-	-
4A0165	CR6L-400	400	-	-
4A0208	CS5F-600	600	-	-
4A0250	CS5F-600	600	-	-
4A0296	CS5F-600	600	-	-
4A0362	CS5F-800	800	-	-
4A0414	CS5F-800	800	-	-
4A0515	CS5F-800	800	-	-
4A0675	CS5F-1000	1000	-	-
4A0930	CS5F-1200	1200	-	-
4A1200	CS5F-1500	1500	-	-

Note: Required UL/CE certification, kindly refers to user guide for details.



Global Service Network



Region	Service Area	Service Location	Service Agency	Telephone/Fax
North America	U.S.A.	Chicago (HQ) Los Angeles San Francisco New Jersey Boston Ohio North Carolina	① YASKAWA AMERICA INC.	Headquarters ☎ +1-847-887-7000 FAX +1-847-887-7310
	Mexico	Mexico City	② PILLAR MEXICANA. S.A. DE C.V.	☎ +52-555-660-5553 FAX +52-555-651-5573
South America	South America	São Paulo	③ YASKAWA ELÉTRICO DO BRASIL LTDA.	☎ +55-11-3585-1100 FAX +55-11-5581-8795
	Colombia	Bogota	④ VARIADORES LTD.A.	☎ +57-1-428-4225 FAX +57-1-428-2173
Europe	Europe, South Africa	Frankfurt	⑤ YASKAWA EUROPE GmbH	☎ +49-6196-569-300 FAX +49-6196-569-398
Asia	Japan	Tokyo, offices nationwide	⑥ YASKAWA ELECTRIC CORPORATION (Manufacturing, sales)	☎ +81-3-5402-4502 FAX +81-3-5402-4580
			⑦ YASKAWA ELECTRIC ENGINEERING CORPORATION (After-sales service)	☎ +81-4-2931-1810 FAX +81-4-2931-1811
	South Korea	Seoul	⑧ YASKAWA ELECTRIC KOREA CORPORATION (Sales)	☎ +82-2-784-7844 FAX +82-2-784-8495
			⑨ YASKAWA ENGINEERING KOREA CORPORATION (After-sales service)	☎ +82-2-3775-0337 FAX +82-2-3775-0338
	China	Beijing, Guangzhou, Shanghai	⑩ YASKAWA ELECTRIC (CHINA) CO., LTD.	☎ +86-21-5385-2200 FAX +86-21-5385-3299
	Taiwan	Taipei	⑪ YASKAWA ELECTRIC TAIWAN CORPORATION	☎ +886-2-2502-5003 FAX +886-2-2505-1280
	Singapore	Singapore	⑫ YASKAWA ELECTRIC (SINGAPORE) PTE LTD	☎ +65-6282-3003 FAX +65-6289-3003
	Thailand	Bangkok	⑬ YASKAWA ELECTRIC (THAILAND) CO., LTD.	☎ +66-2-017-0099 FAX +66-2-017-0090
	India	Bangalore	⑭ YASKAWA INDIA PRIVATE LIMITED	☎ +91-80-4244-1900 FAX +91-80-4244-1901
	Indonesia	Jakarta	⑮ PT. YASKAWA ELECTRIC INDONESIA	☎ +62-21-2982-6470 FAX +62-21-2982-6471
			⑯ YASKAWA ELECTRIC VIETNAM CO., LTD	☎ +84-8-3822-8680 FAX +84-8-3822-8780
	Vietnam	Ho Chi Minh	⑯ YASKAWA ELECTRIC VIETNAM CO., LTD	☎ +84-4-3634-3953 FAX +84-4-3654-3954
Hanoi				
Oceania	Australia	Contact to service agency in Singapore (⑫).		

E1000

Yaskawa Singapore Group

YASKAWA ELECTRIC (SINGAPORE) PTE LTD

151 Lorong Chuan, #04-02A
(Lift Lobby A)
New Tech Park, Singapore 556741
SINGAPORE
Tel: +65-6282-3003 (general) +65-6282-1601 (after-sales)
Fax: +65-6289-3003 (general) +65-6382-3668 (after-sales)
Email: info.ysp@yaskawa.com.sg
Website: www.yaskawa.com.sg

YASKAWA ELECTRIC (THAILAND) CO., LTD.

59, 1st - 5th Floor, Flourish Building,
Soi Ratchadapisek 18, Ratchadapisek Road,
Huaykwang, Bangkok 10310
THAILAND
Tel: +66 2017 0099
Fax: +66 2017 0090
Email: yaskawa@yaskawa.co.th
Website: www.yaskawa.co.th

PT.YASKAWA ELECTRIC INDONESIA

Secure Building - Gedung B Lantai dasar & Lantai 1
Jl. Raya Protokol Halim Perdana Kusuma
Jakarta 13610
INDONESIA
Tel: +62 21 2982 6470
Fax: +62 21 2982 6471
Website: www.yaskawa.co.id

YASKAWA ELECTRIC VIETNAM CO., LTD

Ho Chi Minh Office
Suite 1104, 11th Floor,
Saigon Tower 29 Le Duan, Ben Nghe,
Dist 1, Ho Chi Minh City
VIETNAM
Tel: +84 8 3822 8680
Fax: +84 8 3822 8780

Hanoi Office
2nd Floor, Somerset Hoa Binh Hanoi
VIETNAM
Tel: +84 4 3634 3953
Fax: +84 4 3654 3954



Yaskawa Electric (Singapore) Pte Ltd

In the event that the end user of this product is to be the military and said product is to be employed in any weapons systems or the manufacture thereof, the export will fall under the relevant regulations as stipulated in the Foreign Exchange and Foreign Trade Regulations. Therefore, be sure to follow all procedures and submit all relevant documentation according to any and all rules, regulations and laws that may apply.
Specification, rated values and dimensions are subject to change without notice for ongoing product modifications and improvements.

Document No.: YSP-KAJP-C710616-E1D-3
Published in January 2016